

# Saint Peter Catholic School

Greenville, NC

## Middle School Computer-Aided Design Artwork and 3D Prints 2018-19 School Year

John Bell III, MFA     K-8<sup>th</sup> Grade Art Teacher



**3D prints of student CAD (Sketch Up) drawings are shown on display in a school hallway.**

Students at Saint Peter begin to learn the basics of computer-aided design (CAD) in third grade art class.

Middle school students may choose CAD work as their emphasis in art class.

Computer-aided design with Sketch Up is a conceptual extension of the geometry-based sculptures that students create in the primary and intermediate grades at our school.

# Selected photos of 3D prints and CAD (computer-aided design) drawings by Saint Peter Catholic School Students

In art class, students learn techniques that they apply creatively within the parameters of assignments. Churches, roller coasters, animals, rings, and other projects are displayed in this document.



Wright, 6<sup>th</sup> grade

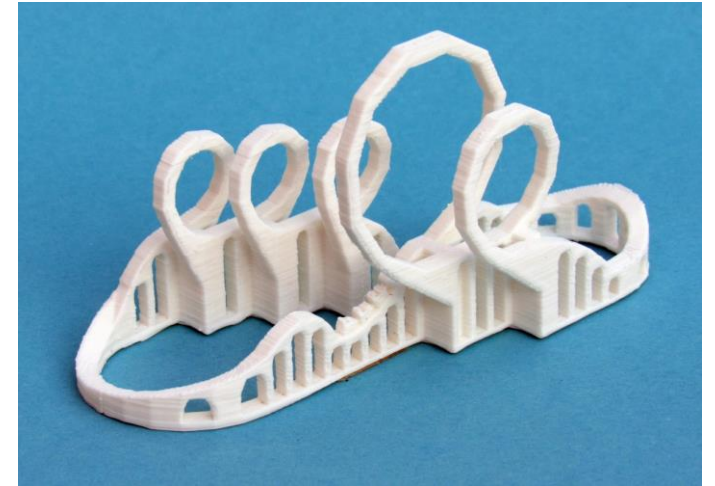
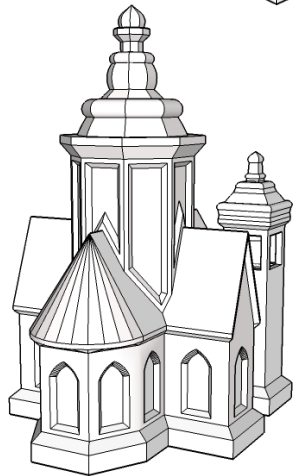

Jasmine, 7<sup>th</sup> grade

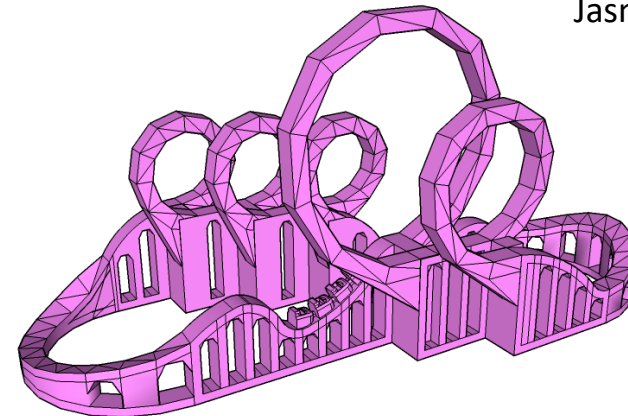



# Saint Peter Catholic School Student Art



Brayden, 6<sup>th</sup> grade

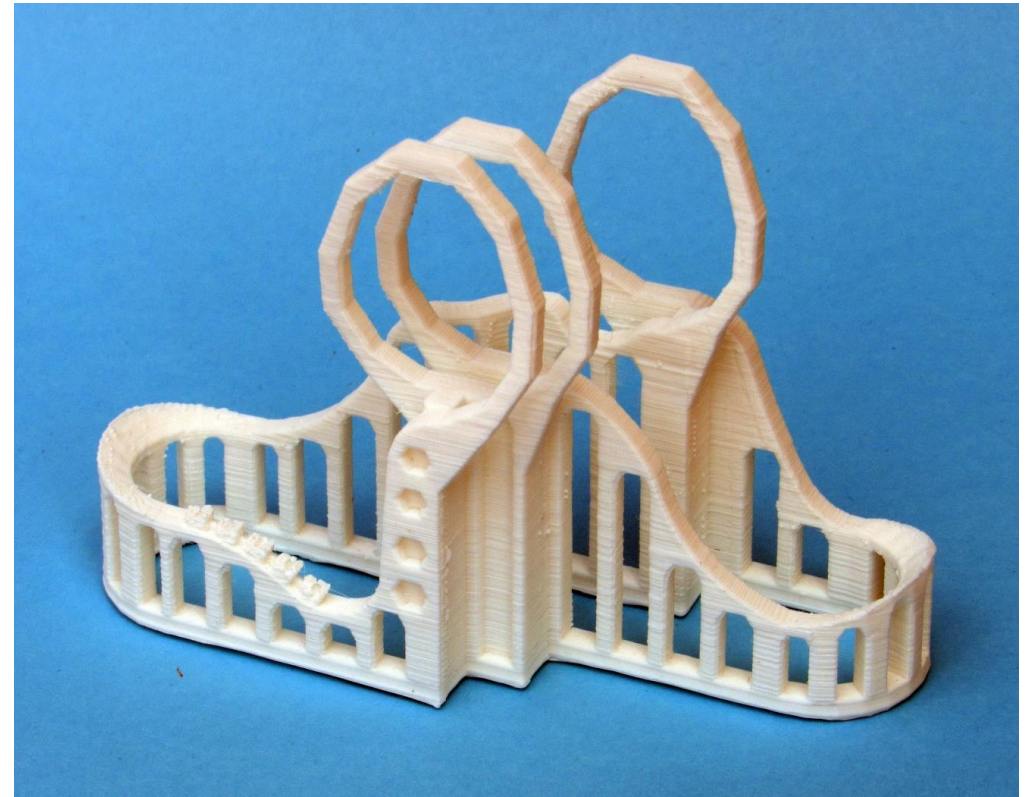
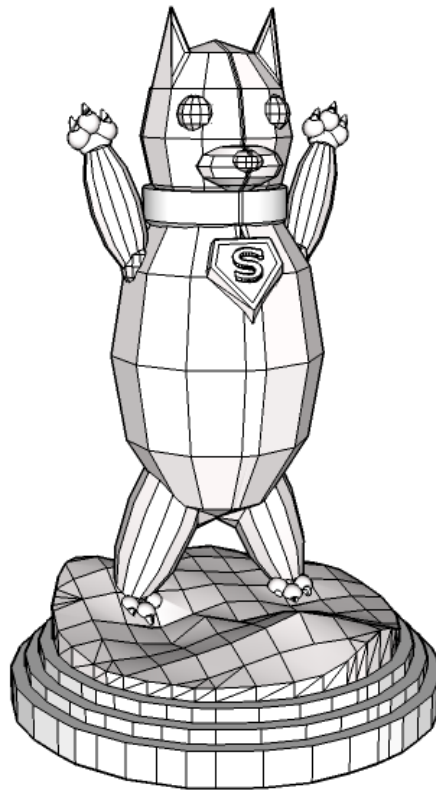

Tiago, 7<sup>th</sup> grade

# Saint Peter Catholic School Student Art



Jasmine, 7<sup>th</sup> grade

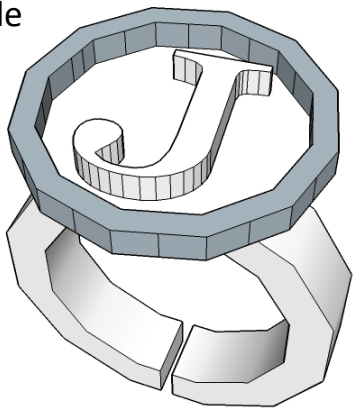

Michelle, 7<sup>th</sup> grade



Jack, 6<sup>th</sup> grade



# Saint Peter Catholic School Student Art



Joe Henry, 6<sup>th</sup> grade

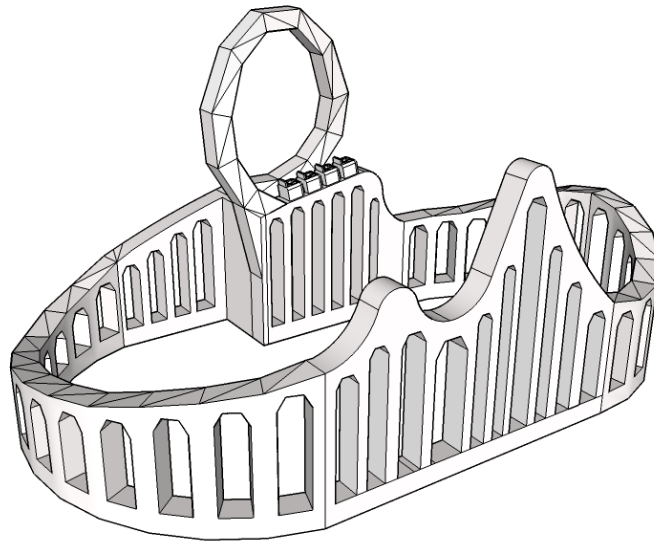

Lincoln, 8<sup>th</sup> grade



Stuart, 8<sup>th</sup> grade

# Saint Peter Catholic School Student Art



Sunook, 6<sup>th</sup> grade

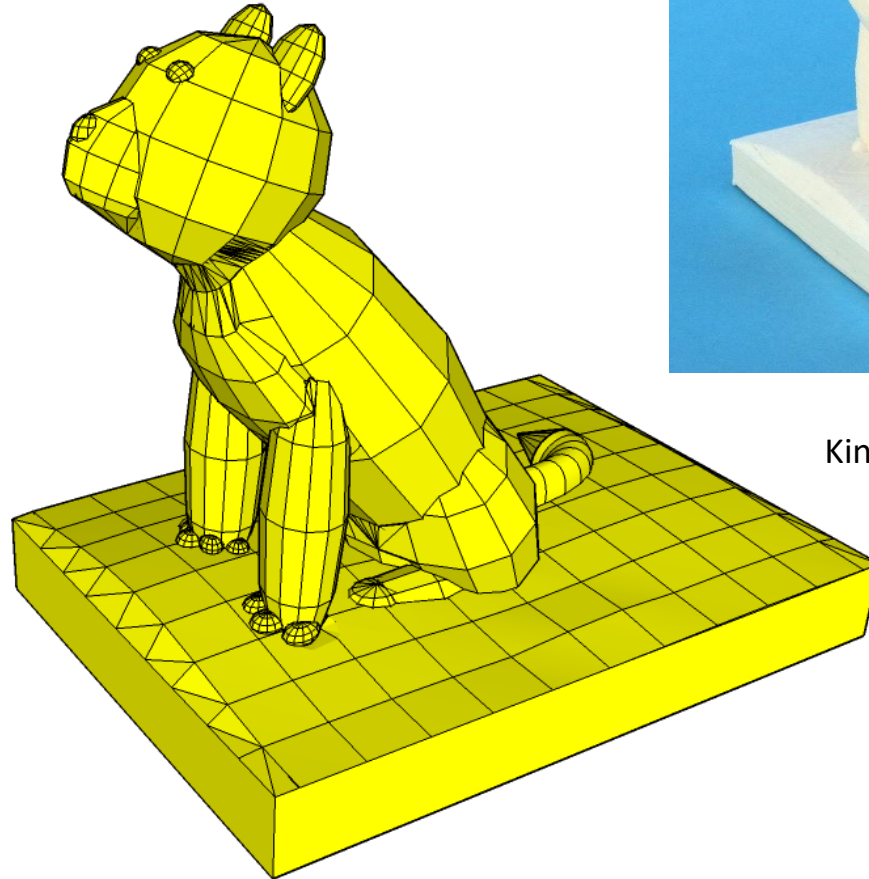

Kinsley Tate, 8<sup>th</sup> grade





# Saint Peter Catholic School Student Art



Janoy, 7<sup>th</sup> grade

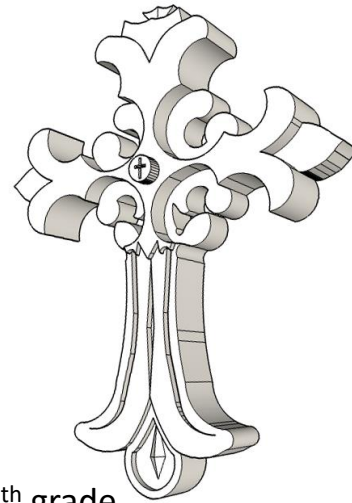

Jasmine, 7<sup>th</sup> grade



Gerald, 7<sup>th</sup> grade



Jeremiah, 8<sup>th</sup> grade

# Saint Peter Catholic School Student Art



Carter, 6<sup>th</sup> grade

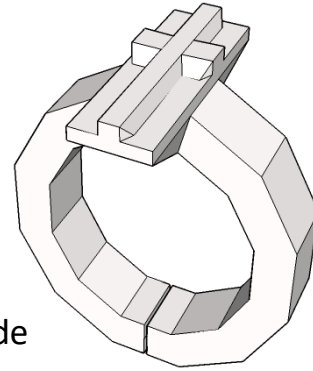

Luke, 7<sup>th</sup> grade

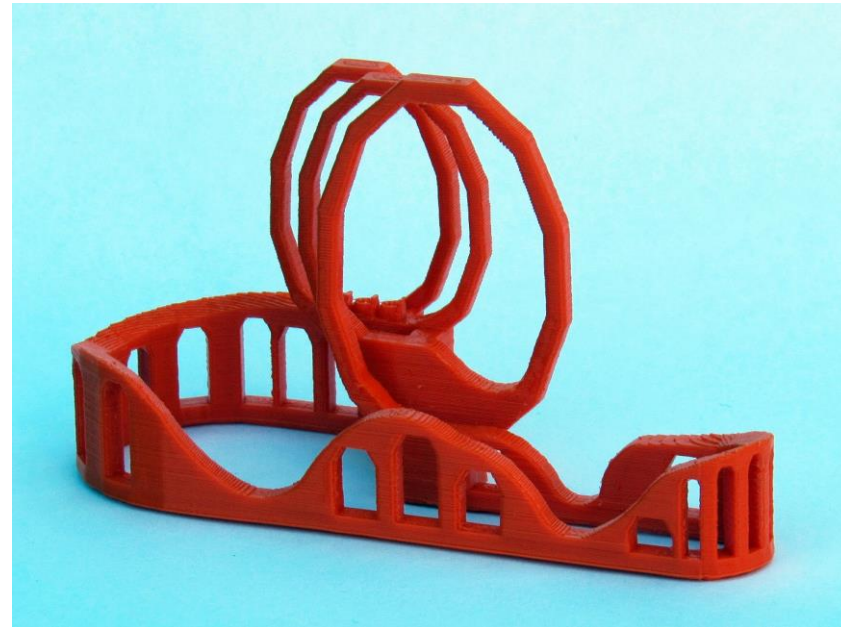

Rylan, 7<sup>th</sup> grade

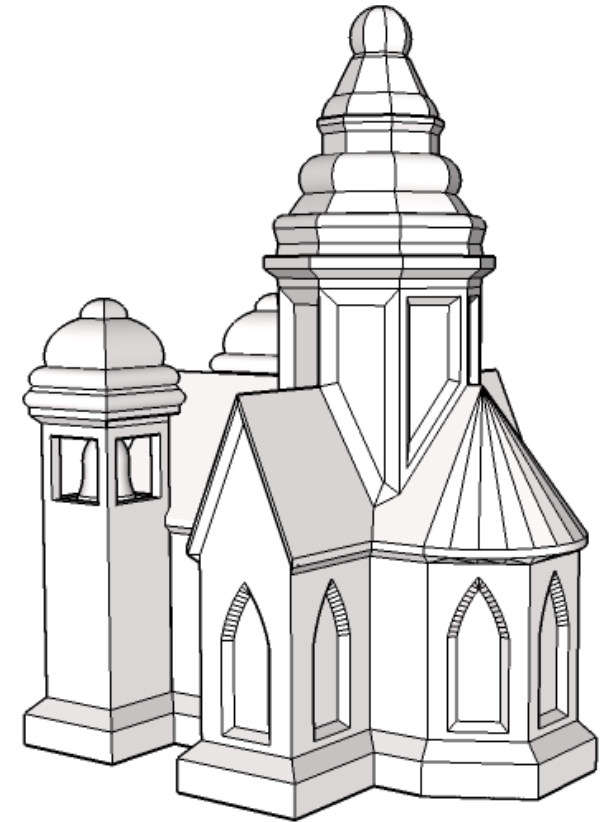

Ryan, 6<sup>th</sup> grade



# Saint Peter Catholic School Student Art

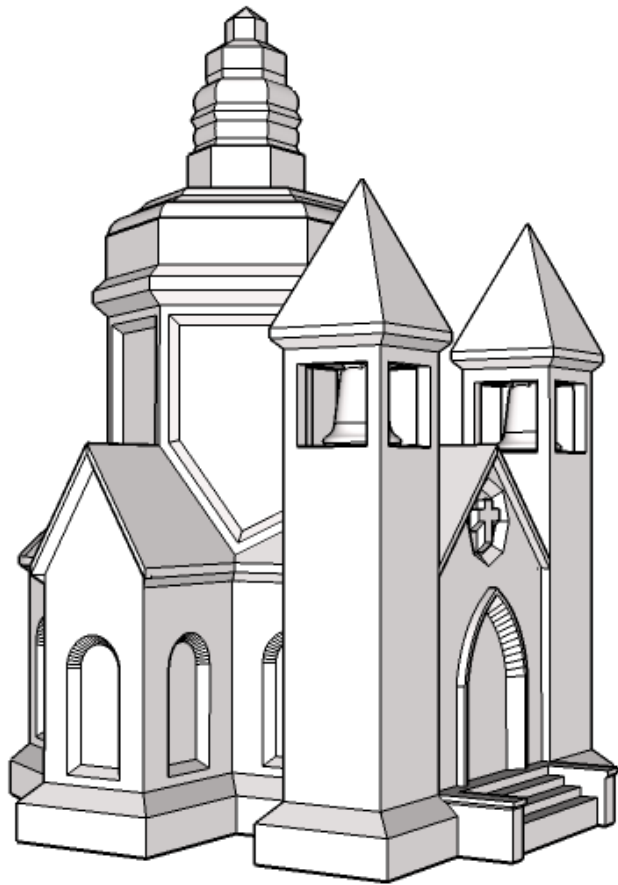

Hayes, 6<sup>th</sup> grade

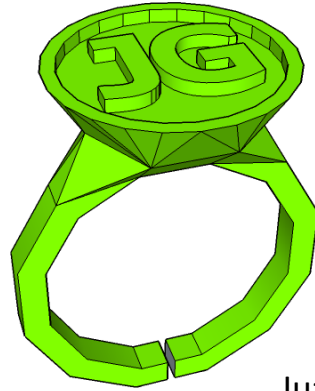

Juan, 8<sup>th</sup> grade

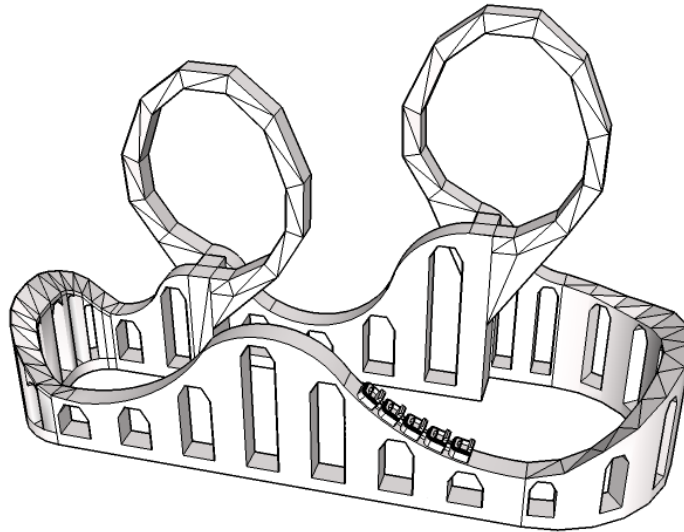

Will, 8<sup>th</sup> grade

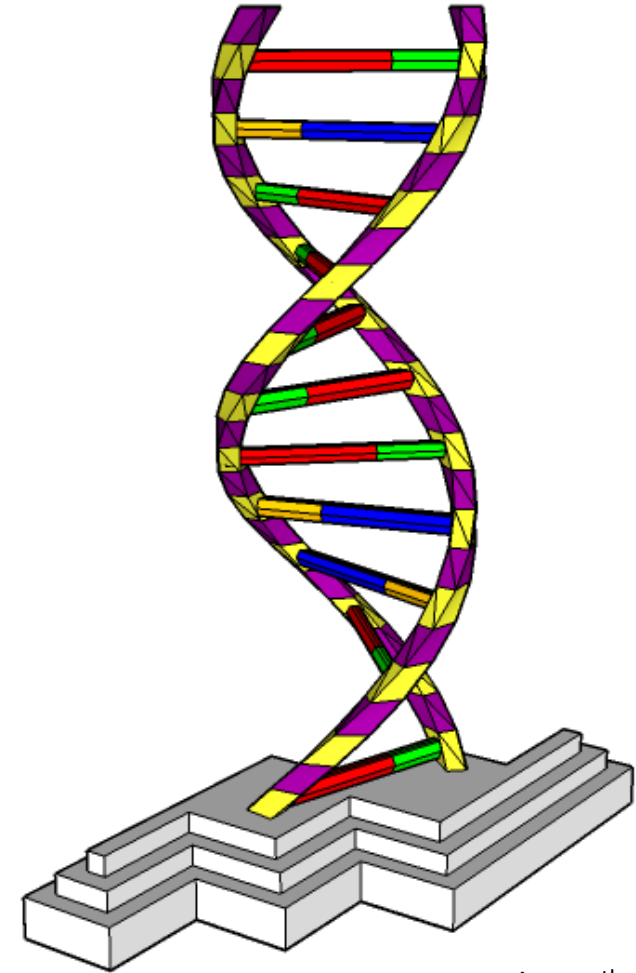

Brayden, 6<sup>th</sup> grade

# Saint Peter Catholic School Student Art

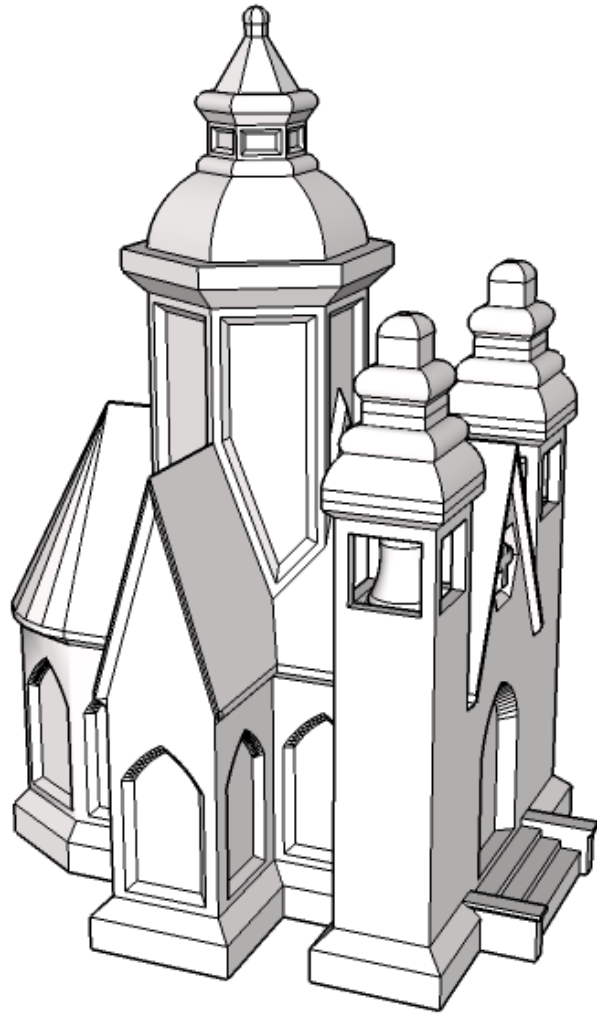

Mark, 6<sup>th</sup> grade

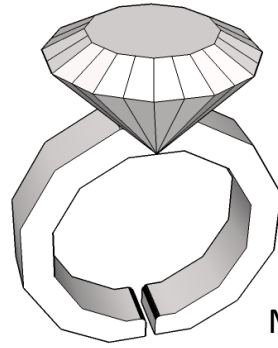

Michelle, 7<sup>th</sup> grade



Luke, 7<sup>th</sup> grade

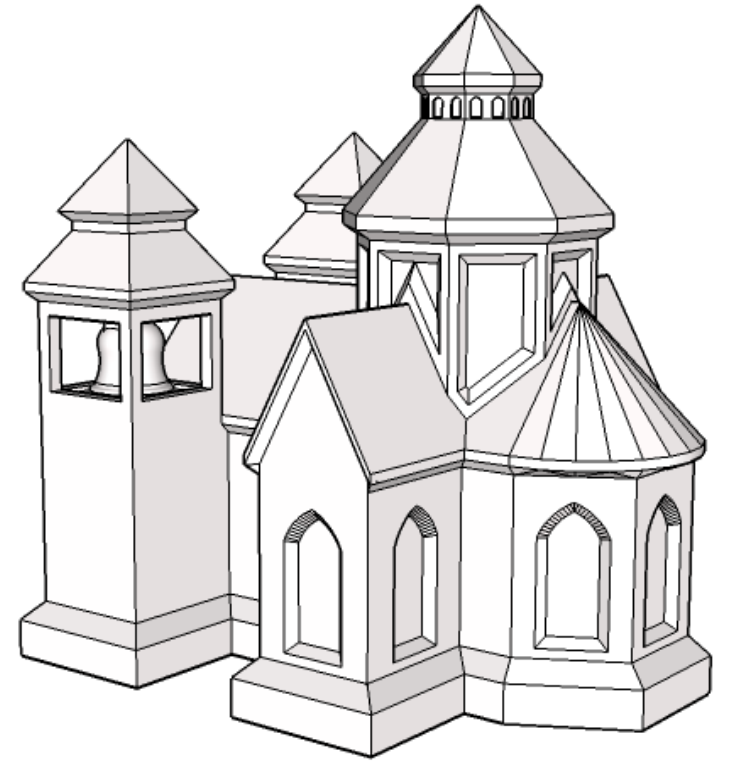

Carson, 6<sup>th</sup> grade



# Saint Peter Catholic School Student Art

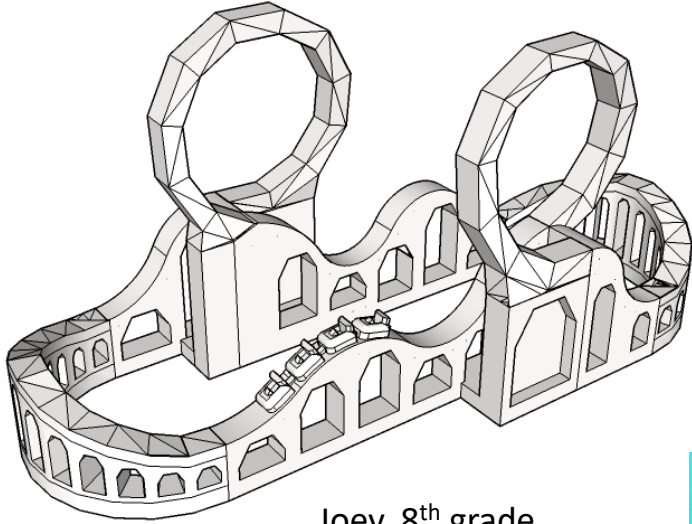

Joey, 8<sup>th</sup> grade

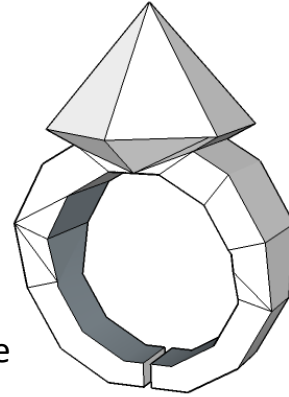

Jamie, 7<sup>th</sup> grade

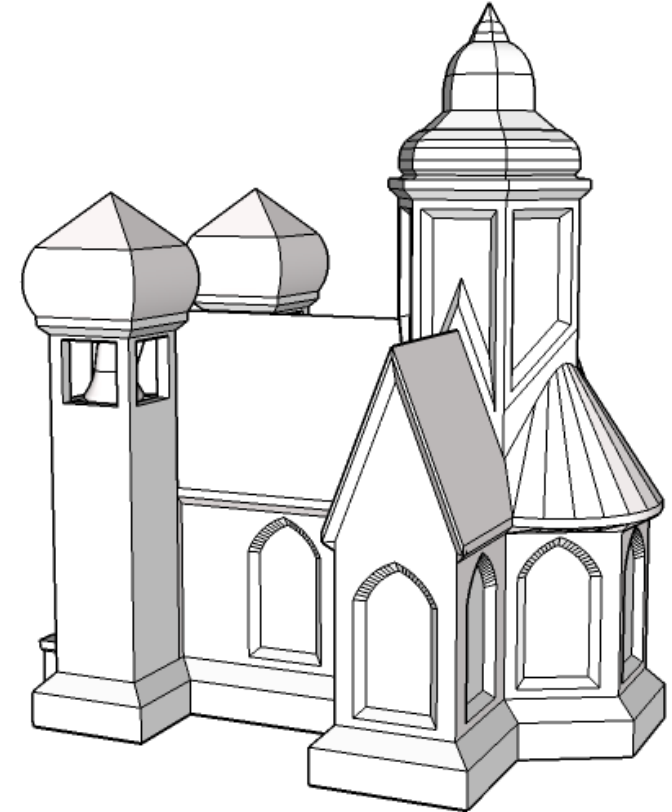

Will, 6<sup>th</sup> grade

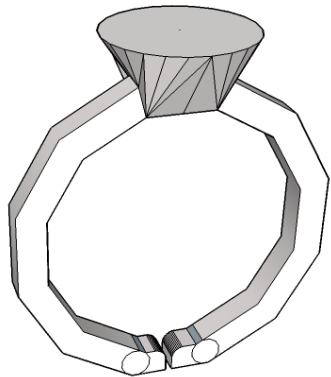

Emma, 8<sup>th</sup> grade

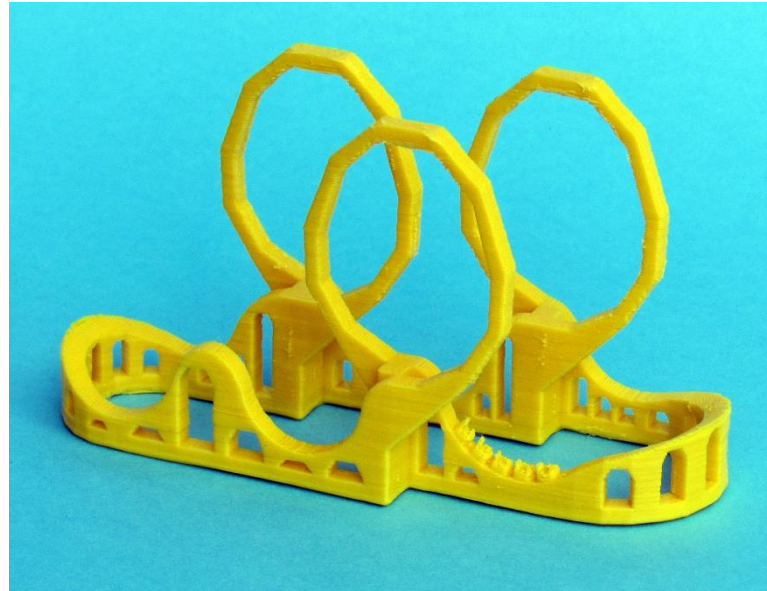

Michelle, 7<sup>th</sup> grade

# Saint Peter Catholic School Student Art

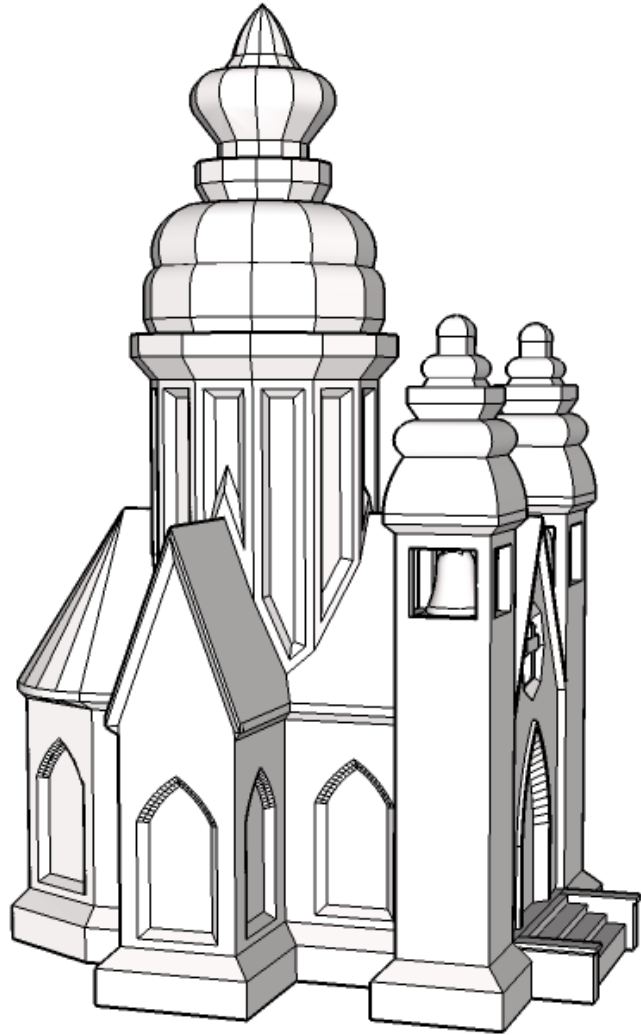

Ryan, 6<sup>th</sup> grade

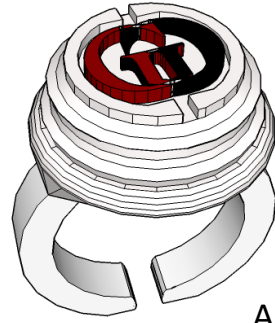

Alex, 7<sup>th</sup> grade

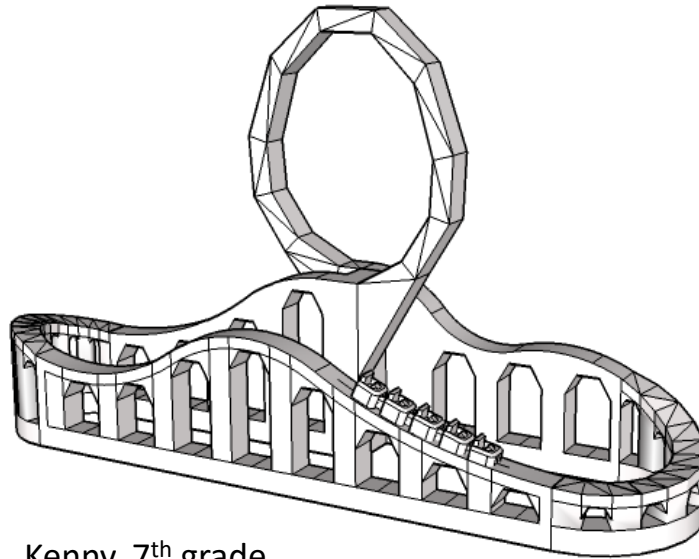

Kenny, 7<sup>th</sup> grade

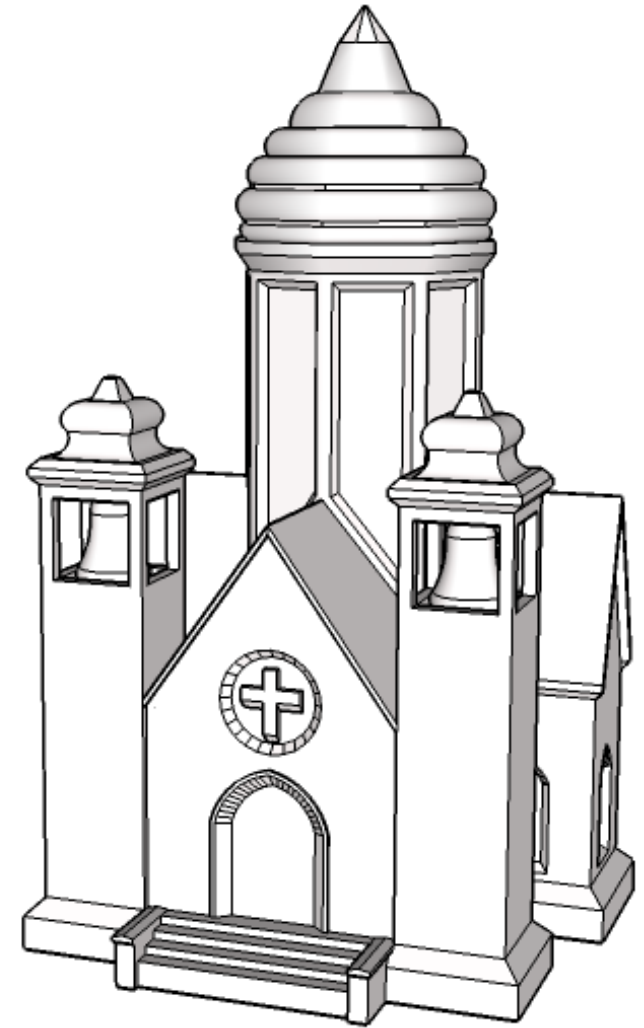

Jake, 6<sup>th</sup> grade



# Saint Peter Catholic School Student Art



Brayden, 6<sup>th</sup> grade

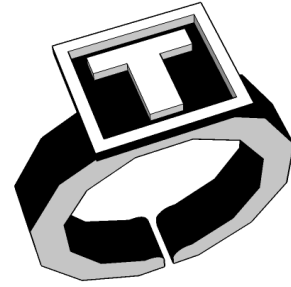

Tiago, 7<sup>th</sup> grade

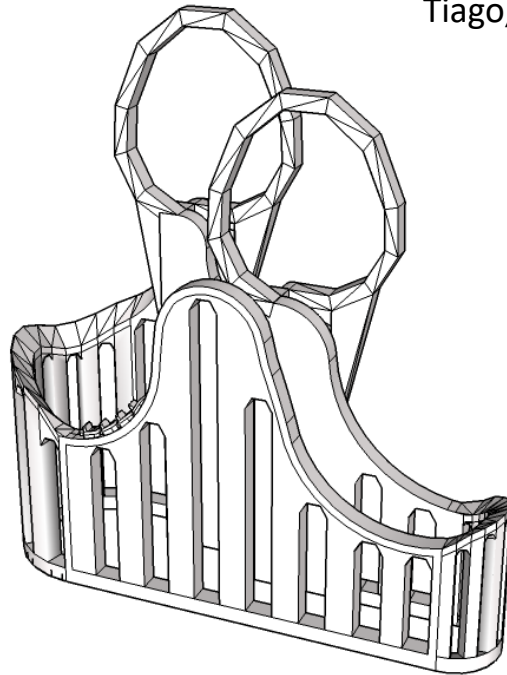

Kinsley Tate, 8<sup>th</sup> grade



Stuart, 8<sup>th</sup> grade

# Saint Peter Catholic School Student Art

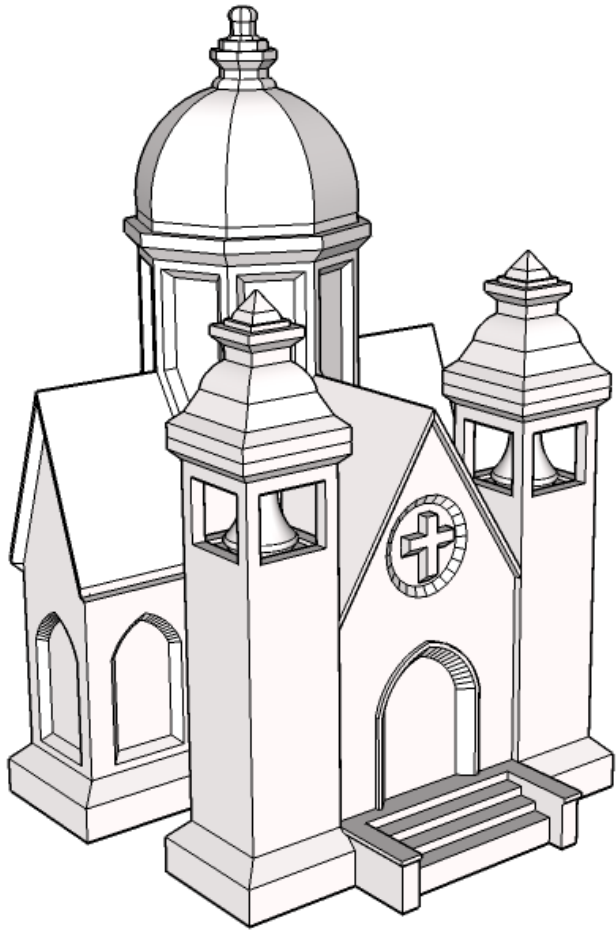

Jack, 6<sup>th</sup> grade

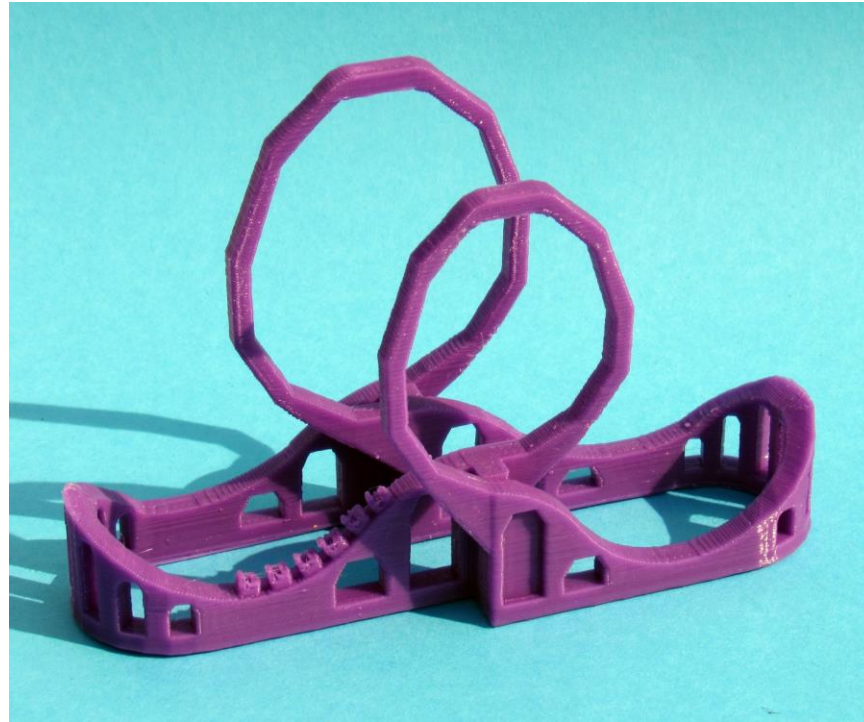

Jamie, 7<sup>th</sup> grade

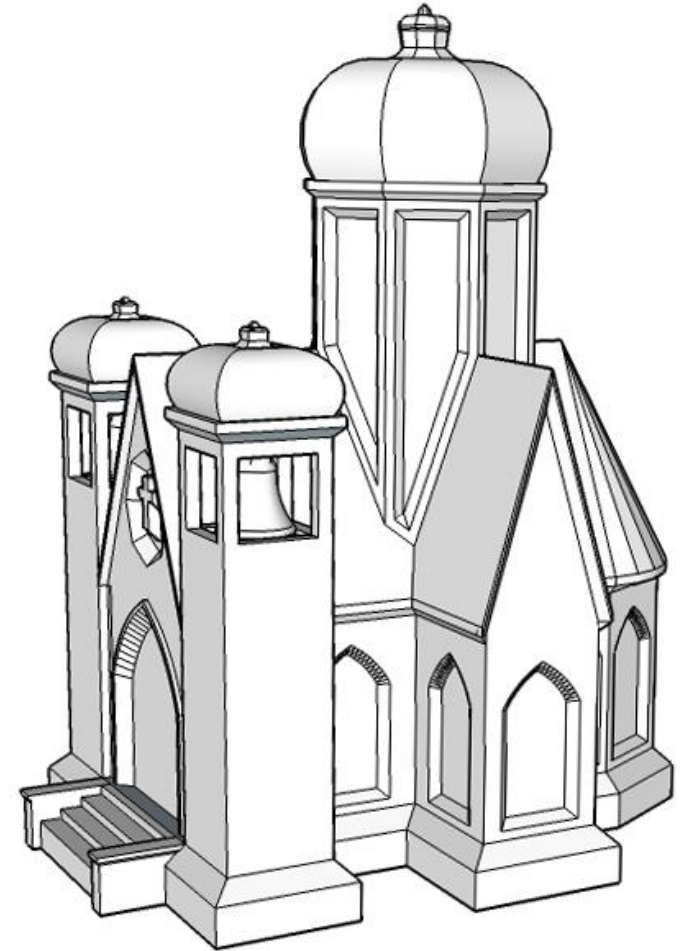

Parker, 6<sup>th</sup> grade



# Saint Peter Catholic School Student Art

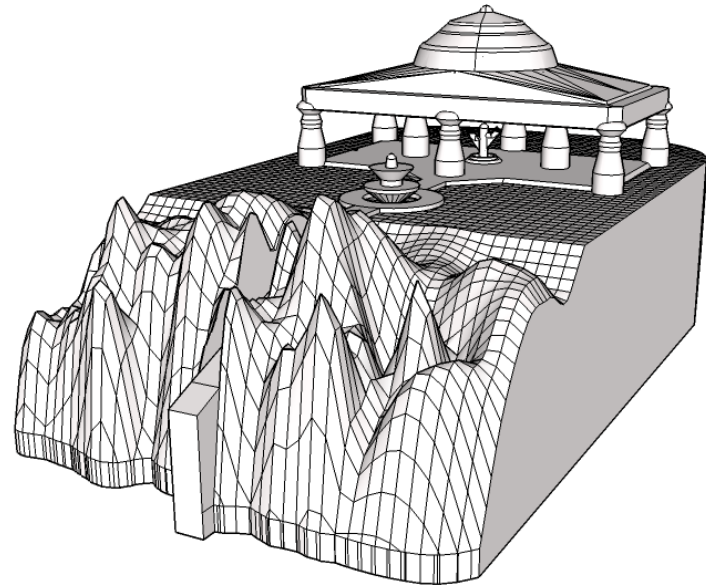

Stuart, 8<sup>th</sup> grade

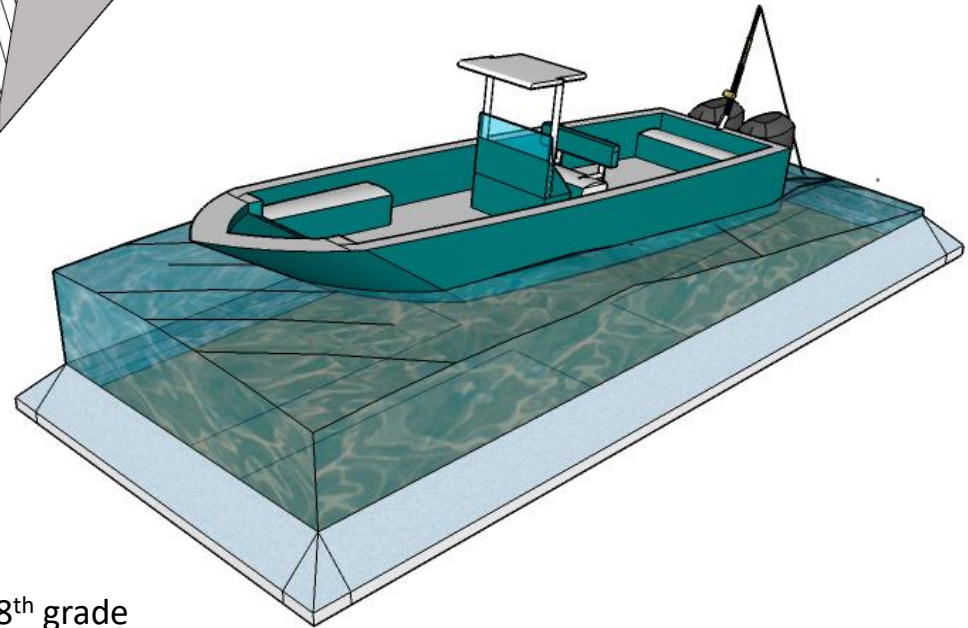
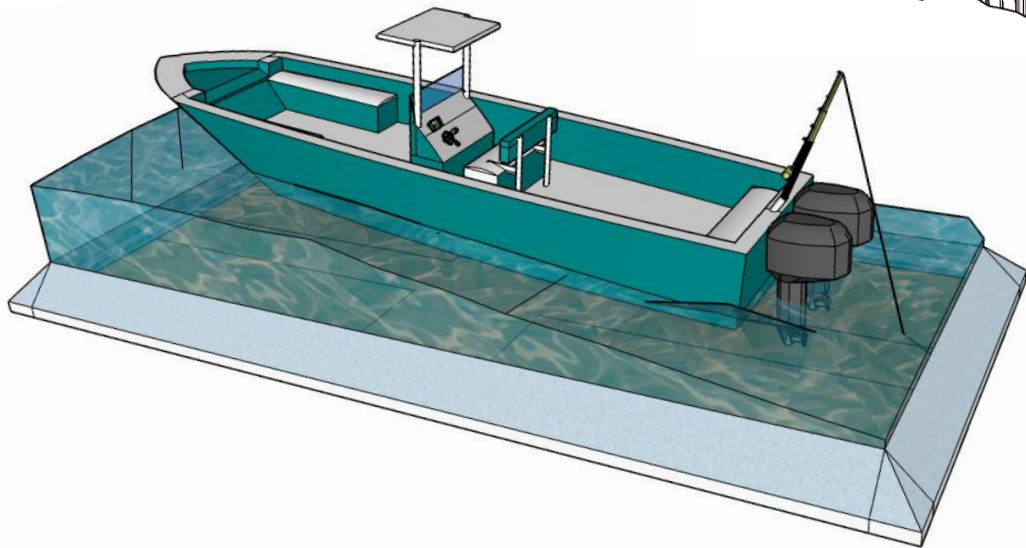

Jackson, 8<sup>th</sup> grade

These drawings of a boat were created for photographic (2D) presentation, rather than for 3D printing.

# Saint Peter Catholic School Student Art

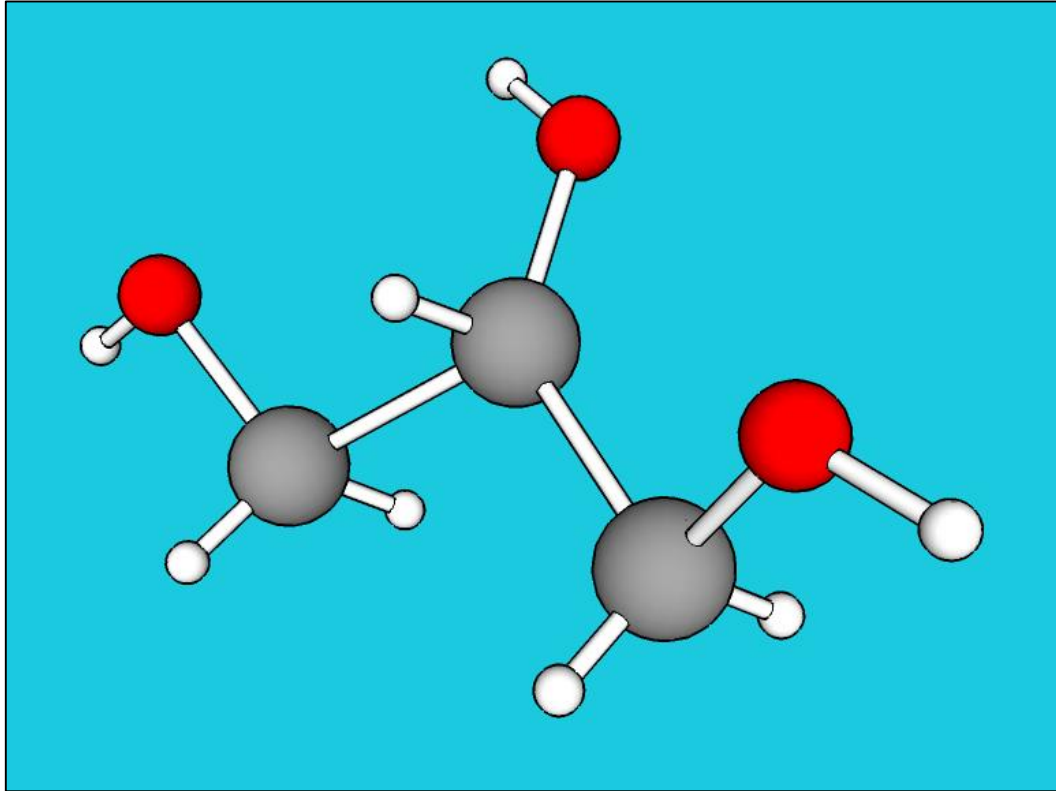

Jeremiah, 8<sup>th</sup> grade



Jackson, 8<sup>th</sup> grade

These drawings of a glycerol molecule ( $C_3H_8O_3$ ) and the first floor of a house were created for photographic (2D) presentation, rather than for 3D printing.